

Din 41612 Q/2 Type (2 Row) 2.54 & 5.08 mm Pitch

- Current Rating: 2A
- Voltage Rating: 250 VACrms 60Hz
- Current Rating: 2A
- Contact Resistance: 30 milliohm max. at 1 amp DC
- Insulation Resistance: 1000 megohms at 500 VDC.
- Dielectric: 1000 VAC rms 60Hz for 1 min.
- Contacts: Female: Phosphor bronze full gold
Male: Brass
- Housing: Glass filled thermoplastic UL94VO rated

Part No 32-149 xx

xx = No of Contacts, 16 or 32 @ 2.54mm pitch

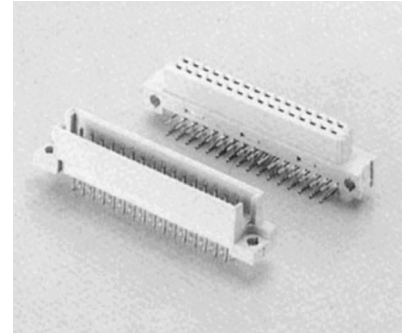

Other sizes available on request

Male

Female

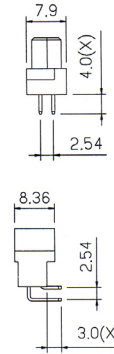
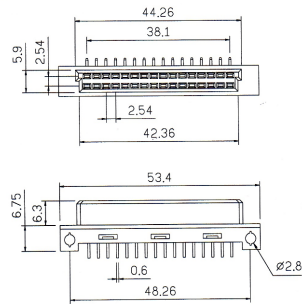
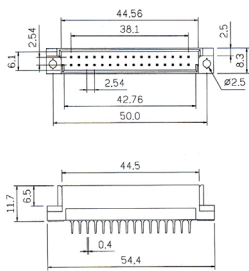

Female

Male

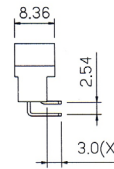

Alligator Clips

Used for creating a temporary electrical connection

Part Number	L1	CØ	Ampere
32-CA32	35.0	3.0	2A
32-CA36	40.0	3.0	3A
32-CA50	50.0	4.0	5A

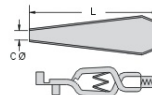
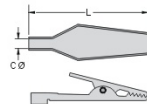

- Available in black and red. Add R or B after part number for red or black clip eg 32-CA32R